

Approximation results for the weighted P_4 partition problem [★]

Jérôme Monnot ^a Sophie Toulouse ^b

^a *Université Paris Dauphine, LAMSADE, CNRS UMR 7024, 75016 Paris, France, monnot@lamsade.dauphine.fr*

^b *Université Paris 13, Institut Galilée LIPN, CNRS UMR 7030, 93430 Villetaneuse, France, sophie.toulouse@lipn.univ-paris13.fr, +33.1.49.40.40.73 (telephone), +33.1.48.26.07.12 (fax)*

Abstract

We present several new standard and differential approximation results for the P_4 -partition problem using the Hassin and Rubinfeld algorithm (Information Processing Letters, 63: 63-67, 1997). Those results concern both minimization and maximization versions of the problem. However, the main point of this paper lies in the establishment of the robustness of this algorithm, in the sense that it provides good quality solutions for a variety of versions of the problem, under both standard and differential approximation ratio.

Key words: graph partitioning, P_4 -packing, approximation algorithms, performance ratio, standard approximation, differential approximation.

1 Introduction

1.1 Definition and hardness of the weighted P_k -partition problem

In the weighted P_k -partition problem (P_kP in short), we are given a complete graph K_{kn} together with a weight function $w : E \rightarrow \mathbb{N}$ on its edges. A P_k is an induced path of length $k - 1$ (or, equivalently, an induced path on k vertices) and the weight of such a path P , denoted by $w(P)$, is the sum of

[★] A preliminary version of this paper appeared in the proceedings the 15th International Symposium on Fundamentals of Computation Theory, FCT 2005, LNCS 3623, (2005) 377-385

its edge weight. Note that the term “path” is somewhat abusive here, since we exclusively work on undirected graphs; hence, by *path*, we actually mean *chain*. Given an instance $I = (K_{kn}, w)$, the aim is to compute a partition $T^* = \{P_1^*, \dots, P_n^*\}$ of $V(K_{kn})$ into n vertex-disjoint P_k (what we call a P_k -partition) that is of optimum weight, where the value of a solution T^* is given by $w(T^*) = \sum_{i=1}^n w(P_i^*)$. Hence, if the goal is to maximize (MAXP_kP), then we seek a P_k -partition of maximum weight, and if the goal is to minimize (MINP_kP), then we seek a P_k -partition of minimum weight. When considering the minimization version, we will more often assume that the weight function satisfies the triangle inequality, *i.e.*, $w(x, y) \leq w(x, z) + w(z, y), \forall x, y, z$; $\text{MINMETRICP}_k\text{P}$ will refer to this restriction. Finally, we also deal with a special case of metric instances where the weight function is worth either 1 or 2; the corresponding problems will be denoted by $\text{MAXP}_k\text{P}_{1,2}$ and $\text{MINP}_k\text{P}_{1,2}$. Note that for $k = 2$, a P_2 -partition is a perfect matching and hence, MINP_2P and MAXP_2P both are polynomial-time solvable. On the other hand, all these problems turn to be **NP**-hard for $k \geq 3$, [9,16].

In this paper, we address the approximability of $P_k\text{P}$ when k is worth 4, by analyzing the performance of a specific algorithm under different assumptions on the input. Commonly, a given problem is said to be ρ -approximable if it admits an algorithm that polynomially computes on any instance a solution that is at least (if maximizing, at most if minimizing) ρ times the optimum value. The aim of approximation theory is to provide solutions of guaranteed quality for problems that are hard to solve (intractable), which is the case of MINP_kP and MAXP_kP . Nevertheless, MAXP_kP is standard-approximable for any k , [11]. In particular, MAXP_3P and MAXP_4P are respectively $35/67 - \varepsilon$, [12] and $3/4$, [11] approximable. On the other hand, it is **NP**-hard to approximate MINP_kP within $2^{p(n)}$ for any polynomial p , for any $k \geq 3$; this is due to the fact that the P_k -partition problem, which consists in deciding whether or not a graph admits a partition of its vertex set into P_k , is **NP**-complete, [9,15,16]. Furthermore, even when restricted to metric instances and more specifically for $k = 4$, no approximation rate has (to our knowledge) been established for $\text{MINMETRICP}_k\text{P}$ so far. Note that this latter problem (and $P_k\text{P}$ in general) is closely related to the vehicle routing problem when restricting the route of each vehicle to at most k intermediate stops, [1,8]. As we have already said, we focus here on the weighted P_4 -partition problem. Furthermore, we study the performance of a single algorithm on various versions of this problem. Doing so, we put to the fore the effectiveness of this algorithm by proving that it provides approximation ratios for both standard and differential measures, for both maximization and minimization versions of the problem. But, before going so far, we briefly recall the basis of approximation theory.

1.2 Approximation theory

Consider an instance I of an **NP**-hard optimization problem Π and a polynomial-time algorithm A that computes feasible solutions for Π . Denote respectively by $\text{apx}_\Pi(I)$ the value of a solution computed by A on I , by $\text{opt}_\Pi(I)$ the value of an optimal solution and by $\text{wor}_\Pi(I)$ the value of a worst solution (that corresponds to the optimum value when reversing the optimization goal). The quality of A is expressed by means of approximation ratios that somehow compare the approximate value to the optimum one. So far, two measures stand out from the literature: the *standard* ratio [2] (the most widely used) and the *differential* ratio [3,4,7,10]. The standard ratio is defined by $\rho_\Pi(I, A) = \text{apx}_\Pi(I)/\text{opt}_\Pi(I)$ if Π is a maximization problem, by $\rho_\Pi(I, A) = \text{opt}_\Pi(I)/\text{apx}_\Pi(I)$ otherwise, whereas the differential ratio is defined by $\delta_\Pi(I, A) = (\text{wor}_\Pi(I) - \text{apx}_\Pi(I))/(\text{wor}_\Pi(I) - \text{opt}_\Pi(I))$. Instead of dividing the approximate value by the optimum one, this latter measure divides the distance from a worst solution to the approximate value by the instance diameter. Within the worst case analysis framework and given a universal constant $\varepsilon \geq 1$ (*resp.*, $\varepsilon \leq 1$), an algorithm A is said to be an ε -standard approximation for a maximization (*resp.* a minimization) problem Π if $\rho_{I, A_\Pi}(I) \geq \varepsilon \forall I$ (*resp.*, $\rho_{A_\Pi}(I) \leq \varepsilon \forall I$). With respect to differential approximation, A is said to be ε -differential approximate for Π if $\delta_{A_\Pi}(I) \geq \varepsilon, \forall I$, for a universal constant $\varepsilon \leq 1$. Equivalently, because any solution value is a convex combination of the two values $\text{wor}_\Pi(I)$ and $\text{opt}_\Pi(I)$, an approximate solution value $\text{apx}_\Pi(I)$ will be an ε -differential approximation if for any instance I , $\text{apx}_\Pi(I) \geq \varepsilon \times \text{opt}_\Pi(I) + (1 - \varepsilon) \times \text{wor}_\Pi(I)$ (for the maximization case; reverse the sense of the inequality when minimizing).

1.3 Organization of the paper

This paper is organized as follows: in the second section, we study the relationship between TSP and P_kP under differential ratio; namely, we show how a differential approximation for TSP enables a differential approximation for P_kP . In the third section, that contains the main result of this paper, we propose a complete analysis, from both a standard and a differential point of view, of an algorithm proposed by Hassin and Rubinstein [11]. We prove that, with respect to the standard ratio, this algorithm provides new approximation ratios for METRICP_4P , namely: the approximate solution respectively achieves a 3/2-, a 7/6- and a 9/10-standard approximation for MINMETRICP_4P , $\text{MINP}_4P_{1,2}$ and $\text{MAXP}_4P_{1,2}$. Under differential ratio, the approximate solution is a (1/2)-approximation for general P_4P , a (2/3)-approximation for $P_4P_{a,b}$. The gap between differential and standard ratios that might be reached for a maximization problem may be explained by the

fact that, within the differential framework, the approximate value has to be located within the interval $[\text{wor}(I), \text{opt}(I)]$, instead of $[0, \text{opt}(I)]$ when considering the standard measure. That is the aim of differential approximation: thanks to the reference it does to $\text{wor}(I)$, this measure is both more precise (relevant with respect to the notion of guaranteed performance) and more robust (since minimizing and maximizing turn to be equivalent and more generally, differential ratio is invariant under affine transformation of the objective function). In addition to the new approximation bounds that they provide, the obtained results establish the robustness of the algorithm that is addressed here, since this latter provides good quality solutions, whatever version of the problem we deal with, whatever approximation framework within which we estimate the approximate solutions.

2 From Traveling salesman problem to P_kP

A common technique in order to obtain an approximate solution for MAXP_kP from a Hamiltonian cycle is called the *deleting and turning around* method, see [11,12,8]. Starting from a tour, this method builds k solutions of MAXP_kP and picks the best among them, where the i th solution is obtained by deleting every k th edge from the input cycle, starting from its i th edge. The quality of the output T' obviously depends on the quality of the initial tour; in this way it is proven in [11,12], that any ε -standard approximation for MAXTSP provides a $\frac{k-1}{k}\varepsilon$ -standard approximation for MAXP_kP . From a differential point of view, things are less optimistic: even for $k = 4$, there exists an instance family $(I_n)_{n \geq 1}$ that verifies $\text{apx}(I_n) = \frac{1}{2}\text{opt}_{\text{MAXP}_4\text{P}}(I_n) + \frac{1}{2}\text{wor}_{\text{MAXP}_4\text{P}}(I_n)$. This instance family is defined as $I_n = (K_{8n}, w)$ for $n \geq 1$, where the vertex set $V(K_{8n})$ may be partitioned into two sets $L = \{\ell_1, \dots, \ell_{4n}\}$ and $R = \{r_1, \dots, r_{4n}\}$ in such a way that the associated weight function w is 0 on $L \times L$, 2 on $R \times R$ and 1 on $L \times R$. Thus, for any $n \geq 1$, the following property holds:

Property 1 $\text{apx}(I_n) = 6n$, $\text{opt}_{\text{MAXP}_4\text{P}}(I_n) = 8n$, $\text{wor}_{\text{MAXP}_4\text{P}}(I_n) = 4n$.

Proof. If the initial tour is described as $\Gamma = \{e_1, \dots, e_n, e_1\}$, then the *deleting and turning around* method produces 4 solutions T_1, \dots, T_4 where $T_i = \cup_{j=0}^{n-1} \{e_{j+i}, e_{j+i+1}, e_{j+i+2}\}$ for $i = 1, \dots, 4$ (indices are considered mod n). Figure 1 provides an illustration of this process (the dashed lines correspond to the edges from $\Gamma \setminus T_i$).

Observe that any tour Γ on I_n is an optimum, of total weight $8n$. Indeed, any tour contains as many edges with their two endpoints in L as edges with their two endpoints in R and thus, $w(\Gamma) = |\Gamma \cap L \times R| + 2|\Gamma \cap R \times R| = |\Gamma| = 8n$. Hence, starting from the optimal cycle $\Gamma^* = [r_1, \dots, r_{4n}, \ell_1, \dots, \ell_{4n}, r_1]$, each of the four solutions T_1, \dots, T_4 output by the algorithm (see Figure 1) has value

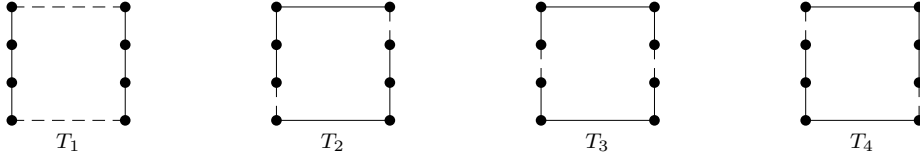

Fig. 1. An example of the 4 solutions T_1, \dots, T_4 .



Fig. 2. A worst solution and an optimal solution when $n = 1$.

$w(T_i) = 6n$, while an optimal solution T^* and a worst solution T_* are of total weight respectively $8n$ and $4n$ (see Figure 2). Indeed, because any P_4 -partition T is a $2n$ edge cut down tour, we get, on the one hand, $\text{opt}_{\text{MAXTSP}}(I_n) \geq w(T)$ and, on the other hand, $w(T) \geq 8n - 4n = 4n$, which concludes this argument. ■

Nevertheless, the deleting and turning around method leads to the following weaker differential approximation relation:

Lemma 2 *From an ε -differential approximation of MAXTSP, one can polynomially compute a $\frac{\varepsilon}{k}$ -differential approximation of MAXP_kP. In particular, we deduce from [10,13] that MAXP_kP is $\frac{2}{3k}$ -differential approximable.*

Proof. Let us show that the following inequality holds for any instance $I = (K_{kn}, w)$ of MAXP_kP:

$$\text{opt}_{\text{MAXTSP}}(I) \geq \frac{1}{k-1} \text{opt}_{\text{MAXP}_k\text{P}}(I) + \text{wor}_{\text{MAXP}_k\text{P}}(I) \quad (1)$$

Let T^* be an optimal solution of MAXP_kP, then arbitrarily add some edges to T^* in order to obtain a tour Γ . From this latter, we can deduce $k-1$ solutions T_i for $i = 1, \dots, k-1$, by applying the deleting and turning around method in such a way that any of the solutions T_i contains $(\Gamma \setminus T^*)$. Thus, we get $(k-1)\text{wor}_{\text{MAXP}_k\text{P}}(I) \leq \sum_{i=1}^{k-1} w(T_i) = (k-1)w(\Gamma) - \text{opt}_{\text{MAXP}_k\text{P}}(I)$. Hence, consider that $w(\Gamma) \leq \text{opt}_{\text{MAXTSP}}(I)$ and the result follows. By applying again the deleting and turning around method, but this time from a worst tour, we may obtain k approximate solutions of MAXP_kP, which allows us to deduce:

$$\text{wor}_{\text{MAXTSP}}(I) \geq \frac{k}{k-1} \text{wor}_{\text{MAXP}_k\text{P}}(I) \quad (2)$$

Finally, let Γ' be an ε -differential approximation of MAXTSP, we deduce from Γ' k approximate solutions of MAXP_kP. If T' is set to the best one, we get $w(T') \geq \frac{k}{k-1}w(\Gamma')$ and thus:

$$\text{apx}(I) \geq \frac{k}{k-1}w(\Gamma') \geq \frac{k}{k-1}(\varepsilon \text{opt}_{\text{MAXTSP}}(I) + (1-\varepsilon)\text{WOR}_{\text{MAXTSP}}(I)) \quad (3)$$

Using inequalities (1), (2) and (3), we get $\text{apx}(I) \geq \frac{\varepsilon}{k}\text{opt}_{\text{MAXP}_k\text{P}}(I) + (1 - \frac{\varepsilon}{k})\text{WOR}_{\text{MAXP}_k\text{P}}(I)$ and the proof is complete. ■

To conclude with the relationship between P_kP and TSP with respect to their approximability, observe that the minimization case also is trickier. Notably, if we consider MINMETRICP₄P, then the instance family $I'_n = (K_{8n}, w')$ built as the same as I_n with a distinct weight function defined as $w'(\ell_i, \ell_j) = w'(r_i, r_j) = 1$ and $w'(\ell_i, r_j) = n^2 + 1$ for any i, j , then we have: $\text{opt}_{\text{TSP}}(I'_n) = 2n^2 + 8n$ and $\text{opt}_{\text{P}_4\text{P}}(I'_n) = 6n$.

3 Approximating P₄P by means of optimal matchings

Here starts the analysis, from both a standard and a differential point of view, of an algorithm proposed by Hassin and Rubinfeld in [11], where the authors show that the approximate solution is a 3/4-standard approximation for MAXP₄P. First, dealing with the standard ratio, we prove that this algorithm provides a (3/2)-approximation for MINMETRICP₄P and respectively a 7/6 and a (9/10)-approximation for MINP₄P_{1,2} and MAXP₄P_{1,2}. As a corollary of a more general result, we also obtain an alternative proof of the result of [11]. We then prove that, with respect to the differential measure, the approximate solution achieves a (1/2)-approximation in general graphs, for both maximization and minimization versions of the problem. Finally, this latter ratio is raised up to 2/3 when restricting to bi-valued graphs.

3.1 Description of the algorithm

The algorithm proposed in [11] runs in two stages: first, it computes an optimum weight perfect matching M on $I = (K_{4n}, w)$; then, it builds on the edges of M a second optimum weight perfect matching R in order to complete the solution (note that “optimum weight” signifies “*maximum weight*” if the goal is to maximize, “*minimum weight*” if the goal is to minimize). Precisely, we define the instance $I' = (K_{2n}, w')$ (having a vertex v_e in K_{2n} for each edge $e \in M$), where the weight function w' is defined as follows: for any edge $[v_{e_1}, v_{e_2}]$ on I' , $w'(v_{e_1}, v_{e_2})$ is set to the weight of the heaviest

edge that links e_1 and e_2 in I , that is, if $e_1 = [x_1, y_1]$ and $e_2 = [x_2, y_2]$, then $w'(v_{e_1}, v_{e_2}) = \max \{w(x_1, x_2), w(x_1, y_2), w(y_1, x_2), w(y_1, y_2)\}$ (when dealing with the minimization version of the problem, set the weight to the lightest). We thus build on (K_{2n}, w') an optimum weight matching R , which is then transposed to the initial graph (K_{4n}, w) by selecting on K_{4n} the edge that realizes the same weight. Since the computation of an optimum weight perfect matching is polynomial, the whole algorithm runs in polynomial time, whether the goal is to minimize or to maximize.

3.2 General P_4P within the standard framework

For any solution T , we denote respectively by M_T and R_T the set of the end edges and the set of the middle edges of its paths. Furthermore, we consider for any path $P_T = \{x, y, z, t\}$ of the solution the edge $[t, x]$ that completes P_T into a cycle. If \overline{R}_T denotes the set of these edges, we observe that $R_T \cup \overline{R}_T$ forms a perfect matching. Finally, for any edge $e \in T$, we will denote by $P_T(e)$ the P_4 from the solution that contains e and by $C_T(e)$ the 4-edge cycle that contains $P_T(e)$.

Lemma 3 *For any instance $I = (K_{4n}, w)$ with an optimal solution T^* , and a perfect matching M , there exist four pairwise disjoint edge sets A , B , C and D that verify:*

- (i) $A \cup B = T^*$ and $C \cup D = \overline{R}_{T^*}$.
- (ii) $A \cup C$ and $B \cup D$ both are perfect matchings on I .
- (iii) $A \cup C \cup M$ is a perfect 2-matching on I whose cycles are of length a multiple of 4.

Proof. Let $T^* = M_{T^*} \cup R_{T^*}$ be an optimal solution, we apply the following process:

-
- 1 Set $A = M_{T^*}$, $B = R_{T^*}$, $C = \emptyset$, $D = \overline{R}_{T^*}$;
Set $G' = (V, A \cup C \cup M)$ (consider the simple graph);
 - 2 While there exists an edge $e \in R_{T^*}$ that links two connected components of G' , do:
 - 2.1 move $C_{T^*}(e) \cap M_{T^*}$ from A to B ;
move $C_{T^*}(e) \cap R_{T^*}$ from B to A ;
move $C_{T^*}(e) \cap \overline{R}_{T^*}$ from D to C ;
 - 2.2 $G' \leftarrow (V, A \cup C \cup M)$;
 - 3 Output A , B , C and D ;

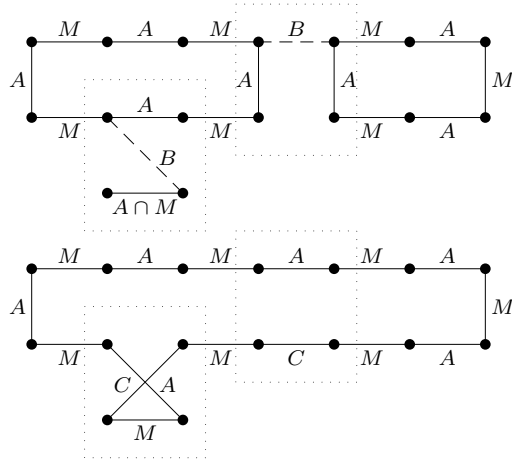

Fig. 3. The construction of sets A and C .

At the initialization stage, the connected components of the partial graph induced by $(A \cup C \cup M)$ are either cycles that alternate edges from $(A \cup C)$ and M , or isolated edges from $M_{T^*} \cap M$. During step 2, at each iteration, the process merges together two connected components of G' into a single cycle that still alternates edges from $(A \cup C)$ and M (an illustration of this merging process is provided in Figure 3). Note that all along the process, the sets A , B , C and D define a partition of $T^* \cup \overline{R}_{T^*}$ and thus, remain pairwise disjoint.

- For (i): Immediate from definition of the process (edges from T^* are moved from A to B , from B to A , but never out of $A \cup B$; the same holds for \overline{R}_{T^*} and the two sets C and D).

- For (ii): At the initialization stage, $A \cup C$ and $B \cup D$ respectively coincide with M_{T^*} and $R_{T^*} \cup \overline{R}_{T^*}$, each a perfect matching. More precisely, for any path P_{T^*} from the optimal solution, if C_{T^*} denotes the associated 4-edge cycle, then $A \cup C$ and $B \cup D$ respectively contain the perfect matching $C_{T^*} \cap M_{T^*}$ and $C_{T^*} \cap (R_{T^*} \cup \overline{R}_{T^*})$ on $V(P_{T^*})$. Now, at each iteration, the algorithm swaps the perfect matchings that are used in $A \cup C$ or $B \cup D$ in order to cover the vertices of a given path P_{T^*} and thus, both $A \cup C$ and $B \cup D$ remain perfect matchings.

- For (iii): At the end of the process, $(A \cup C) \cap M = \emptyset$ and thus, because $A \cup C$ and M both are perfect matchings, then $A \cup C \cup M$ is a perfect 2-matching. Now, consider a cycle Γ of $G' = (V, A \cup C \cup M)$; by definition of step 2, any edge e from R_{T^*} that is incident to Γ has its two endpoints in $V(\Gamma)$, which means that Γ contains either the two edges of $C_{T^*}(e) \cap M_{T^*}$, or the two edges of $C_{T^*}(e) \cap (R_{T^*} \cup \overline{R}_{T^*})$. In other words, if any vertex u from any path $P_{T^*} \in T^*$ belongs to $V(\Gamma)$, then the whole vertex set $V(P_{T^*})$ actually is a subset of $V(\Gamma)$ and therefore, we deduce that $|V(\Gamma)| = 4k$. ■

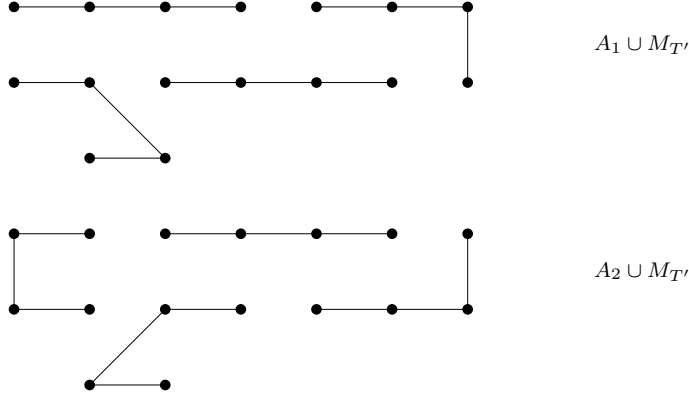

Fig. 4. Two possible P_4 partitions deduced from $A \cup C \cup M_{T'}$.

Theorem 4 *The solution T' provided by the algorithm achieves a $\frac{3}{2}$ -standard approximation for $\text{MINMETRICP}_4\text{P}$ and this ratio is tight.*

Proof. Let T^* be an optimal solution on $I = (K_{4n}, w)$, we consider four pairwise disjoint sets A , B , C and D in accordance with the application of Lemma 3 to the perfect matching $M_{T'}$ of the solution T' . According to property (iii), we can split $A \cup C$ into two sets A_1 and A_2 in such a way that $A_i \cup M_{T'}$ ($i = 1, 2$) is a P_4 -partition (see Figure 4 for an illustration). Hence, A_i constitutes an alternative solution for $R_{T'}$ and because this latter is optimal on $I' = (K_{2n}, w')$, we obtain:

$$2w(R_{T'}) \leq w(A) + w(C) \quad (4)$$

Moreover, item (ii) of Lemma 3 states that $B \cup D$ is a perfect matching; since $M_{T'}$ is an optimum weight matching, it thus verifies:

$$w(M_{T'}) \leq w(B) + w(D) \quad (5)$$

Hence, it suffices to sum inequalities (4) and (5) (and also to consider item (i) of Lemma 3) in order to obtain:

$$w(M_{T'}) + 2w(R_{T'}) \leq w(T^*) + w(\overline{R}_{T^*}) \quad (6)$$

Now, because I satisfies the triangle inequality, we observe that $w(\overline{R}_{T^*}) \leq w(T^*)$ and thus deduce from inequality (6):

$$w(M_{T'}) + 2w(R_{T'}) \leq 2\text{opt}_{\text{MINMETRICP}_4\text{P}}(I) \quad (7)$$

Relation (7) together with $w(M_{T'}) \leq w(M_{T^*}) \leq w(T^*)$ complete the proof. Finally, the tightness is provided by the instance family $I_n = (K_{8n}, w)$ that has been described in Property 1. \blacksquare

Concerning the maximization case and using Lemma 3, one can also obtain an alternative proof of the result given in [11].

Theorem 5 *The solution T' provided by the algorithm achieves a $\frac{3}{4}$ -standard approximation for MAXP_4P .*

Proof. The inequality (6) becomes

$$w(M_{T'}) + 2w(R_{T'}) \geq \text{opt}_{\text{MAXP}_4\text{P}}(I) + w(\overline{R}_{T'}) \quad (8)$$

On the other hand, inequality (7) is no longer true when maximizing. Nevertheless, the approximate value obviously verifies $2 \times w(M_{T'}) \geq \text{opt}_{\text{MAXP}_4\text{P}}(I) + w(\overline{R}_{T'})$; hence, we deduce $\text{apx}_{\text{MAXP}_4\text{P}}(I) \geq \frac{3}{4} (\text{opt}_{\text{MAXP}_4\text{P}}(I) + w(\overline{R}_{T'}))$. ■

3.3 General P_4P within the differential framework

When dealing with the differential ratio, MINP_4P , $\text{MINMETRICP}_4\text{P}$, and MAXP_4P are equivalent to approximate, since P_kP problems belong to the class *FGNPO*, [14]. Note that such an equivalence is more generally true for any couple of problems that only differ by an affine transformation of their objective function.

Theorem 6 *The solution T' provided by the algorithm achieves a $\frac{1}{2}$ -differential approximation for P_4P and this ratio is tight.*

Proof. We consider the maximization version. First, observe that $\overline{R}_{T'}$ is an n -cardinality matching. Let M be any perfect matching of I such that $M \cup \overline{R}_{T'}$ forms a P_4 -partition, we have:

$$w(M) + w(\overline{R}_{T'}) \geq \text{wor}_{\text{MAXP}_4\text{P}}(I) \quad (9)$$

Adding inequalities (8) and (9), and since $w(M_{T'}) \geq w(M)$, we conclude that:

$$\begin{aligned} 2\text{apx}_{\text{MAXP}_4\text{P}}(I) &= 2(w(M_{T'}) + w(R_{T'})) \geq \text{wor}_{\text{MAXP}_4\text{P}}(I) + \text{opt}_{\text{MAXP}_4\text{P}}(I) \\ &\Rightarrow \frac{\text{apx}_{\text{MAXP}_4\text{P}}(I) - \text{wor}_{\text{MAXP}_4\text{P}}(I)}{\text{opt}_{\text{MAXP}_4\text{P}}(I) - \text{wor}_{\text{MAXP}_4\text{P}}(I)} \geq 1/2 \end{aligned}$$

In order to establish the tightness of this ratio, we refer to Property 1. ■

3.4 Bi-valued metric P_4P with weights 1 & 2 within the standard framework

As it has been recently done for MINTSP in [5,6] and because such an analysis enables a keener comprehension of a given algorithm, we now focus on instances where any edge weight is either 1 or 2. Note that, since the P_4 -partition problem is **NP**-complete, the problems $\text{MAX}P_4P_{1,2}$ and $\text{MIN}P_4P_{1,2}$ still are **NP**-hard.

Let us first introduce some more notation. For a given instance $I = (K_{4n}, w)$ of $P_4P_{1,2}$ with $w(e) \in \{1, 2\}$, we denote by $M_{T',i}$ (*resp.*, $R_{T',i}$) the set of edges from $M_{T'}$ that are of weight i . If we aim at maximizing, then p (*resp.*, q) indicates the cardinality of $M_{T',2}$ (*resp.*, of $R_{T',2}$); otherwise, it indicates the quantity $|M_{T',1}|$ (*resp.*, $|R_{T',1}|$). In any case, p and q respectively count the number of “*optimum weight weight edges*” in the sets $M_{T'}$ and $R_{T'}$. With respect to the optimal solution, we define the sets $M_{T^*,i}$, $R_{T^*,i}$ for $i = 1, 2$ and the cardinalities p^* , q^* as the same. Wlog., we may assume that the following property always holds for T^* :

Property 7 For any 3-edge path $P \in T^*$,

$$|P \cap M_{T^*,2}| \geq |P \cap R_{T^*,2}| \quad \text{if the goal is to maximize,}$$

$$|P \cap M_{T^*,1}| \geq |P \cap R_{T^*,1}| \quad \text{if the goal is to minimize.}$$

Proof. Assume that the goal is to maximize. If $|P \cap M_{T^*,2}| < |P \cap R_{T^*,2}|$, then T^* would contain a path $P = \{[x, y], [y, z], [z, t]\}$ with $w(x, y) = w(z, t) = 1$ and $w(y, z) = 2$; thus, by swapping P for $P' = \{[y, z], [z, t], [t, x]\}$ within T^* , one could generate an alternative optimal solution. ■

Lemma 8 For any instance $I = (K_{4n}, w)$, if T' is a feasible solution and T^* is an optimal solution, then there exists an edge set A that verifies:

- (i) $A \subseteq M_{T^*,2} \cup R_{T^*,2}$ (*resp.*, $A \subseteq M_{T^*,1} \cup R_{T^*,1}$) and $|A| = q^*$ if the goal is to maximize (*resp.*, to minimize);
- (ii) $G' = (V, M_{T'} \cup A)$ is a simple graph made of pairwise disjoint chains.

Proof. We only prove the maximization case. We now consider G' the multi-graph induced by $M_{T'} \cup R_{T^*,2}$ (the edges from $M_{T'} \cap R_{T^*,2}$ appear twice). This graph consists of elementary cycles and chains: its cycles alternate edges from $M_{T'}$ and $R_{T^*,2}$ (note that the 2-edge cycles correspond to the edges from $R_{T^*,2} \cap M_{T'}$); its chains (that may be of length 1) also alternate edges from $M_{T'}$ and $R_{T^*,2}$, with the particularity that their end edges all belong to $M_{T'}$.

Let Γ be a cycle on G' and e be an edge from $\Gamma \cap R_{T^*,2}$. If $P_{T^*}(e) = \{x, y, z, t\}$ denotes the path from the optimal solution that contains e , then $e = [y, z]$. The initial vertex x of the path $P_{T^*}(e)$ necessarily is the endpoint of some

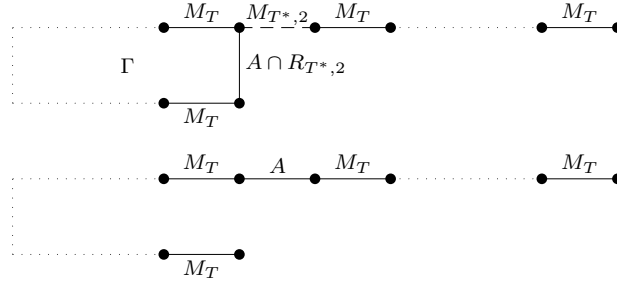

Fig. 5. The construction of set A .

chain from G' : otherwise, the edge $[x, y]$ from $P_{T^*}(e) \cap M_{T^*}$ would be incident to 2 distinct edges from R_{T^*} , which would contradict the fact that T^* is a P_4 partition. The same obviously holds for t . W.l.o.g., we may assume from Property 7 that $[x, y] \in M_{T^*,2}$. In light of these remarks and in order to build an edge set A that fulfills the requirements (i) and (ii), we proceed as follows:

-
- 1 Set $A = R_{T^*,2}$;
Set $G' = (V, A \cup M_{T'})$ (consider the multi-graph);
 - 2 While there exists a cycle Γ in G' , do:
 - 2.1 pick e from $\Gamma \cap R_{T^*,2}$;
pick f from $P_{T^*}(e) \cap M_{T^*,2}$;
 $A \leftarrow A \setminus \{e\} \cup \{f\}$;
 - 2.2 $G' \leftarrow (V, A \cup M_{T'})$;
 - 3 output A ;
-

By construction, the set A output by the algorithm is of cardinality q^* and contains exclusively edges of weight 2. Furthermore, by the stopping criterion of the step 2, and because each iteration of this step merges a cycle and a chain into a chain, $G' = (V, A \cup M_T)$ is a simple graph of whose connected components are elementary chains (an illustration of this step is provided by Figure 5). Finally, the existence of edge f at step 2.1 directly comes from the above discussion. ■

Theorem 9 *The solution T' provided by the algorithm achieves a $\frac{9}{10}$ -standard approximation for $\text{MAXP}_4\text{P}_{1,2}$ and a $\frac{7}{6}$ -standard approximation for $\text{MINP}_4\text{P}_{1,2}$. These ratios are tight.*

Proof. Let consider A the edge subset of the optimal solution that may be deduced from the application of Lemma 8 to the approximate solution. We

arbitrarily complete A by means of an edge set B in such a way that $A \cup B \cup M_{T'}$ constitutes a perfect 2-matching. As we did while proving Theorem 4, we split the edge set $A \cup B$ into two sets A_1 and A_2 in order to obtain two P_4 -partitions $M_{T'} \cup A_1$ and $M_{T'} \cup A_2$ of $V(K_{4n})$. As both A_1 and A_2 complete $M_{T'}$ into a P_4 -partition and because $R_{T'}$ is optimal, we deduce that A_i does not contain more “good weight edges” than $R_{T'}$, that is: $q \geq |\{e \in A_i : w(e) = 2\}|$ if the goal is to maximize, $q \geq |\{e \in A_i : w(e) = 1\}|$ otherwise. Since $A \subseteq A_1 \cup A_2$ and $|A| = q^*$, we immediately deduce:

$$q \geq q^*/2 \tag{10}$$

On the other hand, by the optimality of $M_{T'}$:

$$p \geq \max\{p^*, q^*\} \tag{11}$$

Moreover, the quantities p^* and q^* structurally verify:

$$n \geq \max\{p^*/2, q^*\} \tag{12}$$

Finally, we can express the value of any solution T as:

$$w(T) = \begin{cases} 3n + (p + q) & \text{when maximizing,} \\ 6n - (p + q) & \text{when minimizing.} \end{cases} \tag{13}$$

The claimed results can now be obtained from (10), (11), (12) and (13):

$$\begin{aligned} 10\text{apx}_{\text{MAXP}_4\text{P}_{1,2}}(I) &= 10(3n + p + q) \\ &= 9(3n) + 3n + 9p + p + 10q \\ &\geq 9(3n) + 3q^* + 9p^* + q^* + 5q^* \\ &= 9(3n + p^* + q^*) = 9\text{opt}_{\text{MAXP}_4\text{P}_{1,2}}(I) \end{aligned}$$

$$\begin{aligned} 6\text{apx}_{\text{MINP}_4\text{P}_{1,2}}(I) &= 6(6n - p - q) \\ &= 6(6n) - 6p - 6q \\ &\leq 6(6n) - 6p^* - 3q^* + (2n - p^*) + (4n - 4q^*) \\ &\leq 7(6n - p^* - q^*) = 7\text{opt}_{\text{MINP}_4\text{P}_{1,2}}(I) \end{aligned}$$

The tightness for $\text{MAXP}_4\text{P}_{1,2}$ is established in the instance $I = (K_8, w)$ depicted in Figure 6, where the edges of weight 2 are drawn in continuous line, and the edges of weight 1 on T^* and T' are drawn in dotted line

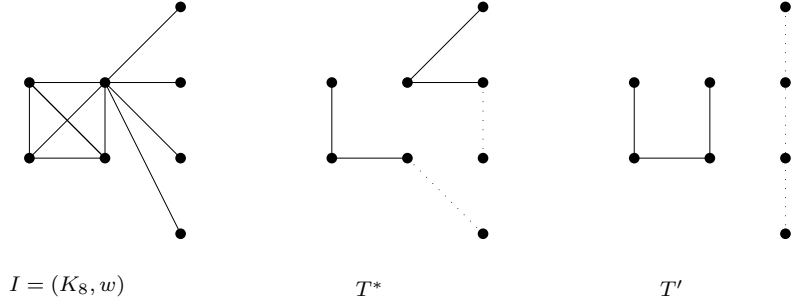

Fig. 6. Instance $I = (K_8, w)$ that establishes the tightness for $\text{MAXP}_4\text{P}_{1,2}$.

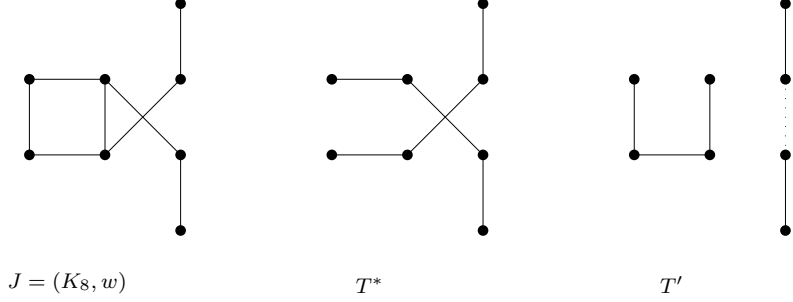

Fig. 7. Instance $I = (K_8, w)$ that establishes the tightness for $\text{MINP}_4\text{P}_{1,2}$.

(other edges are not drawn). One can easily see $\text{opt}_{\text{MAXP}_4\text{P}_{1,2}}(I) = 10$ and $\text{apx}_{\text{MAXP}_4\text{P}_{1,2}}(I) = 9$. Concerning the minimization case, the ratio is tight on the instance $J = (K_8, w)$ that verifies: $\text{opt}(J) = w(T^*) = 6$ and $\text{apx}(J) = w(T') = 7$. $J = (K_8, w)$ is depicted in Figure 7 (the 1-weight edges are drawn in continuous line and the 2-weight edges on T^* and T' are drawn in dotted line). ■

3.5 Bi-valued metric P_4P with weights a and b within the differential framework

As we have already mentioned, the differential measure is invariant under affine transformation; now, any instance from $\text{MAXP}_4\text{P}_{a,b}$ or from $\text{MINP}_4\text{P}_{a,b}$ can be mapped into an instance of $\text{MAXP}_4\text{P}_{1,2}$ by the way of such a transformation. Thus, proving $\text{MAXP}_4\text{P}_{1,2}$ is ε -differential approximable actually establishes that $\text{MINP}_4\text{P}_{a,b}$ and $\text{MAXP}_4\text{P}_{a,b}$ are ε -differential approximable for any couple of real values $a < b$. We demonstrate here that Hassin and Rubinfeld algorithm achieves a $\frac{2}{3}$ -differential approximation for $\text{P}_4\text{P}_{1,2}$ and hence, for $\text{P}_4\text{P}_{a,b}$, for any couple of reals $a < b$.

Let $I = (K_{4n}, w)$ be an instance of $\text{MAXP}_4\text{P}_{1,2}$. We use the notation introduced while proving Theorem 9, namely: $p = |M_{T',2}|$, $p^* = |M_{T^*,2}|$, $q = |R_{T',2}|$ and $q^* = |R_{T^*,2}|$. Furthermore, for $i = 1, 2$, $\mathcal{P}_{T'}^i$ will refer to the set of paths from T' whose central edge is of weight i . Note that the paths from $\mathcal{P}_{T'}^1$ may

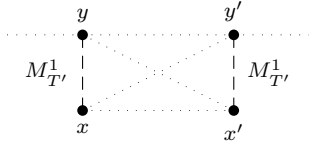

Fig. 8. 1-weight edges on $V(M_{T'}^1)$.

be of total weight 3, 4 or 5, whereas the paths from $\mathcal{P}_{T'}^2$ may be of total weight 5 or 6 (at least one extremal edge must be of weight 2, or $M_{T'}$ is not an optimum). We will denote by $\mathcal{P}_{T',5}^2$ and $\mathcal{P}_{T',6}^2$ the paths from $\mathcal{P}_{T'}^2$ that are of total weight 5 and 6, respectively. Finally, for $i = 1, 2$, $M_{T'}^i$ will refer to the set of edges $e \in M_{T'}$ such that $P_{T'}(e) \in \mathcal{P}_{T'}^i$ (that is, e is element of a path from T' whose central edge has weight i). By (10) and (11):

$$\text{opt}_{\text{MAXP}_4\text{P}_{1,2}}(I) \leq \min \{3n + p + 2q, 3n + 2p\} \quad (14)$$

To obtain a differential approximation, one also has to produce an efficient bound for $\text{wor}_{\text{MAXP}_4\text{P}_{1,2}}(I)$. To do so, we exploit the optimality of $M_{T'}$ and $R_{T'}$ in order to exhibit some edges of weight 1 that will enable us to approximate the worst solution. We first consider the vertices from $V(\mathcal{P}_{T'}^1)$: they are “easy” to cover by means of 3-edge paths of total weight 3, since we may immediately deduce from the optimality of $R_{T'}$ the following property (an illustration is provided by Figure 8, where dotted lines indicate edges of weight 1 and dashed lines indicate unspecified weight edges):

Property 10 $[x, y] \neq [x', y'] \in M_{T'}^1 \Rightarrow \forall e \in \{x, y\} \times \{x', y'\}, w(e) = 1$

We now consider the vertices from $V(\mathcal{P}_{T',5}^2)$. Let $P_{T'} = \{x, y, z, t\}$ with $[x, y] \in M_{T',2}$ be a path from $\mathcal{P}_{T',5}^2$, we deduce from the optimality of $M_{T'}$ that $w(t, x) = 1$; hence, the 3-edge path $P'_{T'} = \{y, z, t, x\}$ covers the vertices $\{x, y, z, t\}$ with a total weight 4. Let us assume that $\mathcal{P}_{T',6}^2 = \emptyset$, then we are able to build a P_4 partition of $V(K_{4n})$ using $3n - |\mathcal{P}_{T',5}^2|$ edges of weight 1 and $|\mathcal{P}_{T',5}^2|$ edges of weight 2 (one edge of weight 2 is used for each path from $\mathcal{P}_{T',5}^2$). Hence, a worst solution costs at most $3n + q$, while the approximate solution is of total weight $3n + p + q$. Thus, using relation (14), we would be able to conclude that T' is a $(2/3)$ -approximation. Of course, there is no reason for $\mathcal{P}_{T',6}^2 = \emptyset$; nevertheless, this discussion has brought to the fore the following fact: the difficult point of the proof lies in the partitioning of $V(\mathcal{P}_{T',6}^2)$ into “light” 3-edge paths. In order to deal with these vertices, we first state two more properties that are immediate from the optimality of $M_{T'}$ and $R_{T'}$, respectively.

Property 11 $[x, y] \in M_{T',1}$ and $[x', y'] \in M_{T',2} \Rightarrow \min \{w(x, x'), w(y, y')\} = \min \{w(x, y'), w(y, x')\} = 1$

Property 12 If $[x, y] \neq [x', y'] \in M_{T'}^1$ and $P_{T'} = \{\alpha, \beta, \gamma, \delta\} \in \mathcal{P}_{T'}^2$, then $\max \{w(e) | e \in \{\alpha, \beta\} \times \{x, y\}\} = 2 \Rightarrow \max \{w(e) | e \in \{\gamma, \delta\} \times \{x', y'\}\} = 1$.

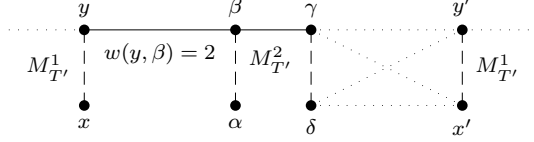

Fig. 9. 1-weight edges that may be deduced from the optimality of $R_{T'}$.

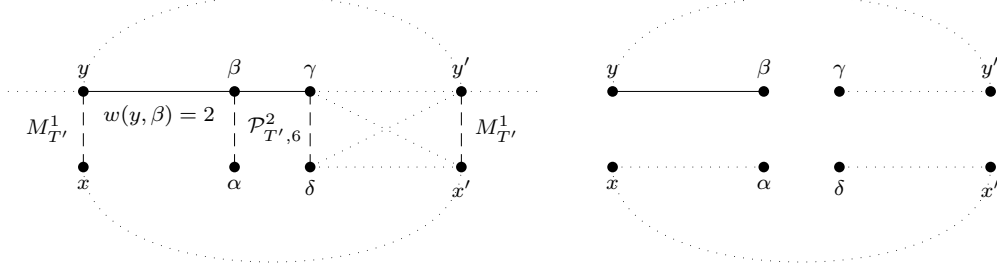

Fig. 10. A P_4 partition of $(P_{T'}, e_1, e_2) \in \mathcal{P}_{T',6}^2 \times (M_{T'}^1)^2$ of total weight at most 7.

From Properties 11 and 12 (see Figure 9 for an illustration of this latter, where continuous and dotted lines respectively indicate 2- and 1-weight edges, whereas dashed lines indicate unspecified weight edges), we now are able to propose a “light” P_4 partition of $\mathcal{P}_{T',6}^2$. This partition is formalized in the following Property illustrated in Figure 10.

Property 13 *Given a path $P_{T'} \in \mathcal{P}_{T',6}^2$ and two edges $[x, y] \neq [x', y'] \in M_{T',1}^1$, then there exists a P_4 partition $\mathcal{P} = \{P_1, P_2\}$ of $(V(P_{T'}) \cup \{x, y, x', y'\})$ that is of total weight at most 8. Furthermore, if $[x, y]$ and $[x', y']$ both belong to $M_{T',1}$, then we can decrease this weight down to (at most) 7.*

Proof. Consider $P_{T'} = \{\alpha, \beta, \gamma, \delta\} \in \mathcal{P}_{T',6}^2$ and $[x, y] \neq [x', y'] \in M_{T',1}^1$. We set $P_1 = \{\alpha, x, x', \delta\}$ and $P_2 = \{\beta, y, y', \gamma\}$. We know from Property 10 that $w(x, x') = w(y, y') = 1$. Thus, if every edge from $\{\alpha, \beta, \gamma, \delta\} \times \{x, x', y, y'\}$ is of weight 1, then $P_1 \cup P_2$ has a total weight 6. Conversely, if there exists a 2-weight edge that links a vertex from $\{\alpha, \beta, \gamma, \delta\}$ to a vertex from $\{x, x', y, y'\}$, we may assume that $[\beta, y]$ is such an edge; we then deduce from Property 12 that $w(\delta, x') = w(\gamma, y') = 1$ and hence, that $P_1 \cup P_2$ is of total weight at most 8. Finally, if $w(x, y) = 1$, then $w(\alpha, x) = 1$ from Property 11 and thus, $w(P_1) + w(P_2) = 7$. ■

We now are able to compute an approximate worst solution that provides an efficient upper bound for $\text{wor}_{\text{MAX}P_4P_{1,2}}(I)$.

Lemma 14 *Let $I = (K_{4n}, w)$ be an instance of $\text{MIN}P_4P_{1,2}$ and let T' be the solution provided by Hassin and Rubinfeld algorithm on I . One can compute on I a solution T_* that verifies :*

$$p_* + q_* \leq q + (|\mathcal{P}_{T',6}^2| - \lfloor p_1/2 \rfloor)^+ + (|\mathcal{P}_{T',6}^2| - n + q)^+$$

where p_* and q_* are defined as $p_* = |M_{T_*,2}|$ and $q_* = |R_{T_*,2}|$ (and expression X^+ is equivalent to $\max\{X, 0\}$).

Proof. The proof is algorithmic. Note that, even though this has no impact on the rightness of the proof, the computation of T_* has a polynomial runtime. This means that the good properties of the approximate solution T' enable to really exhibit an approximate worst solution (and not only to provide an evaluation of such a solution, as it is often the case while stating differential approximation results).

-
- 0 Set $T = T'$, $T_* = \emptyset$;
 - 1 While $\exists \{P, e_1, e_2\} \subseteq T$ s.t. $(P, e_1, e_2) \in \mathcal{P}_{T',6}^2 \times M_{T',1}^1 \times M_{T',1}^1$
 - 1.1 compute $\mathcal{P} = \{P_1, P_2\}$ on $V(P) \cup V(e_1) \cup V(e_2)$ with $w(\mathcal{P}) \leq 7$;
 - 1.2 $T \leftarrow T \setminus \{P, e_1, e_2\}$, $T_* \leftarrow T_* \cup \{P_1, P_2\}$;
 - 2 While $\exists \{P, e_1, e_2\} \subseteq T$ s.t. $(P, e_1, e_2) \in \mathcal{P}_{T',6}^2 \times M_{T'}^1 \times M_{T'}^1$
 - 2.1 compute $\mathcal{P} = \{P_1, P_2\}$ on $V(P) \cup V(e_1) \cup V(e_2)$ with $w(\mathcal{P}) \leq 8$;
 - 2.2 $T \leftarrow T \setminus \{P, e_1, e_2\}$, $T_* \leftarrow T_* \cup \{P_1, P_2\}$;
 - 3 While $\exists P \subseteq T$ s.t. $P \in \mathcal{P}_{T',6}^2$
 - 3.1 $T \leftarrow T \setminus P$, $T_* \leftarrow T_* \cup \{P\}$;
 - 4 While $\exists P \subseteq T$ s.t. $P \in \mathcal{P}_{T',5}^2$
 - 4.1 compute $\mathcal{P} = \{P_1\}$ on $V(P)$ with $w(\mathcal{P}) \leq 4$;
 - 4.2 $T \leftarrow T \setminus P$, $T_* \leftarrow T_* \cup \{P_1\}$;
 - 5 While $\exists \{e_1, e_2\} \subseteq T$ s.t. $(e_1, e_2) \in M_{T'}^1 \times M_{T'}^1$
 - 5.1 compute $\mathcal{P} = \{P_1\}$ on $V(e_1) \cup V(e_2)$ with $w(\mathcal{P}) = 3$;
 - 5.2 $T \leftarrow T \setminus \{e_1, e_2\}$, $T_* \leftarrow T_* \cup \{P_1\}$;
 - 6 Output T_* ;
-

In order to estimate the value of the approximate worst solution T_* , one has to count the number $p_* + q_*$ of 2-weight edges it contains. Let p_i^1 refer to $|M_{T'}^1 \cap M_{T',i}|$ for $i = 1, 2$ (the cardinality p_1^1 enables the expression of the number of iterations during step 1). Steps 1, 2 and 3 respectively put into T_* at most one, two and three 2-weight edges per iteration. Any path from $\mathcal{P}_{T',6}^2$ is treated by one of the three steps 1 to 3. If $2|\mathcal{P}_{T',6}^2| \geq p_1^1$, only $|\mathcal{P}_{T',6}^2| - \lfloor p_1^1/2 \rfloor$ paths from $\mathcal{P}_{T',6}^2$ are treated by one of the steps 2 and 3. Finally, if $|\mathcal{P}_{T',6}^2| \geq |\mathcal{P}_{T'}^1|$, only $|\mathcal{P}_{T',6}^2| - |\mathcal{P}_{T'}^1|$ paths from $\mathcal{P}_{T',6}^2$ are treated during step 3. Furthermore, step 4 puts at most $|\mathcal{P}_{T',5}^2|$ 2-weight edges into T_* (at most one per iteration), while steps 0 and 5 do not incorporate any 2-weight edges within T_* . Thus, considering $q = |\mathcal{P}_{T',5}^2| + |\mathcal{P}_{T',6}^2|$ and $|\mathcal{P}_{T'}^1| = n - q$, we obtain the announced result. \blacksquare

Let us introduce some more notation. Analogous to $\mathcal{P}_{T'}^2 = \mathcal{P}_{T',5}^2 \cup \mathcal{P}_{T',6}^2$, we

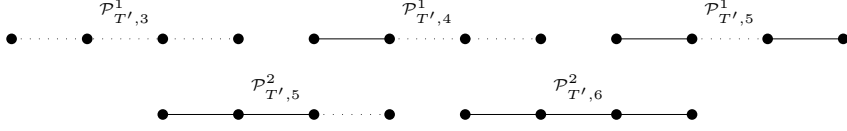

Fig. 11. A partition of T' .

define a partition of $\mathcal{P}_{T'}^1$ into three subsets $\mathcal{P}_{T',3}^1$, $\mathcal{P}_{T',4}^1$ and $\mathcal{P}_{T',5}^1$ according to the path total weight. Note that, since the subsets $\mathcal{P}_{T',j}^1$ define a partition of T' , we have $n = |\mathcal{P}_{T',3}^1| + |\mathcal{P}_{T',4}^1| + |\mathcal{P}_{T',5}^1| + |\mathcal{P}_{T',5}^2| + |\mathcal{P}_{T',6}^2|$ (see Figure 11 for an illustration of this partition; the edges of weight 2 are drawn in continuous lines whereas the edges of weight 1 are drawn in dotted lines).

The following Lemma states three relations between, on the one hand, quantities that participate to the value of the approximate solution and, on the other hand, parts of the value of a worst solution and of the optimal value.

Lemma 15

$$p \geq q^* + (|\mathcal{P}_{T',6}^2| - \lfloor p_1^1/2 \rfloor)^+ \quad (15)$$

$$2q \geq q^* + (|\mathcal{P}_{T',6}^2| + q - n)^+ \quad (16)$$

$$q \geq p_* + q_* - (|\mathcal{P}_{T',6}^2| - \lfloor p_1^1/2 \rfloor)^+ - (|\mathcal{P}_{T',6}^2| + q - n)^+ \quad (17)$$

Proof.

- For (15): Obvious if $|\mathcal{P}_{T',6}^2| \leq \lfloor p_1^1/2 \rfloor$, since $p \geq q^*$ (from inequality (11)). Otherwise, one can write p as the sum $p = n + |\mathcal{P}_{T',6}^2| + |\mathcal{P}_{T',5}^1| - |\mathcal{P}_{T',3}^1|$. Now, $|\mathcal{P}_{T',5}^1| - |\mathcal{P}_{T',3}^1|$ is precisely the half of the difference between the number of 2-weight and of 1-weight edges in $M_{T'}^1$: since $p_2^1 = |\mathcal{P}_{T',4}^1| + 2|\mathcal{P}_{T',5}^1|$ and $p_1^1 = |\mathcal{P}_{T',4}^1| + 2|\mathcal{P}_{T',3}^1|$, then $p_2^1 - p_1^1 = 2(|\mathcal{P}_{T',5}^1| - |\mathcal{P}_{T',3}^1|)$. From this latter equality, we deduce that p_1^1 and p_2^1 have the same parity; hence, we have $(1/2)(p_2^1 - p_1^1) = \lfloor p_2^1/2 \rfloor - \lfloor p_1^1/2 \rfloor$ and thus, $p = n + |\mathcal{P}_{T',6}^2| + \lfloor p_2^1/2 \rfloor - \lfloor p_1^1/2 \rfloor$. Just observe that n and q^* verify $n \geq q^*$ in order to conclude.

- For (16): Obvious if $|\mathcal{P}_{T',6}^2| \leq n - q$, since $2q \geq q^*$ (from inequality (10)). Otherwise, consider that q , n and $|\mathcal{P}_{T',6}^2|$ verify: $q \geq |\mathcal{P}_{T',6}^2|$ and $n \geq q^*$.

- For (17): Immediate from Lemma 15. ■

Theorem 16 *The solution T' provided by the algorithm achieves a $\frac{2}{3}$ -differential approximation for $P_4P_{a,b}$ and this ratio is tight.*

Proof. By summing inequalities (15) to (17), together with $2p \geq 2p^*$, we

obtain the expected result:

$$\begin{aligned}
3\text{apx}_{\text{MAXP}_4\text{P}}(I) &= 3(3n + p + q) \\
&\geq 2(3n + p^* + q^*) + (3n + p_* + q_*) \\
&= 2\text{opt}_{\text{MAXP}_4\text{P}_{1,2}}(I) + \text{wor}_{\text{MAXP}_4\text{P}_{1,2}}(I)
\end{aligned}$$

The tightness is provided by the instance $I = (K_8, w)$ that is shown on Figure 6; since this instance contains some vertex v such that any edge from v is of weight 2, the result follows. ■

References

- [1] E. M. Arkin, R. Hassin, A. Levin, Approximations for minimum and min-max vehicle routing problems, *Journal of Algorithms*, 59:1 (2006) 1-18.
- [2] G. Ausiello, P. Crescenzi, G. Gambosi, V. Kann, A. Marchetti-Spaccamela, M. Protasi, *Complexity and Approximation (Combinatorial Optimization Problems and Their Approximability Properties)*, Springer, Berlin, 1999.
- [3] G. Ausiello, A. D'Atri, M. Protasi, Structure preserving reductions among convex optimization problems, *Journal of Computational System Sciences*, 21 (1980) 136-153.
- [4] M. Bellare, P. Rogaway, The complexity of approximating a nonlinear program, *Mathematical Programming* 69 (1995) 429-441.
- [5] P. Berman, M. Karpinski, 8/7-Approximation Algorithm for 1,2-TSP, *Proc. SODA'06*, 2006 641-648.
- [6] M. Bläser, L. Shankar Ram, An Improved Approximation Algorithm for TSP with Distances One and Two, *Proc. FCT'05, LNCS 3623* (2005) 504-515.
- [7] M. Demange, V. Th. Paschos, On an approximation measure founded on the links between optimization and polynomial approximation theory, *Theoretical Computer Science* 158 (1996) 117-141.
- [8] G. N. Frederickson, M. S. Hecht, C. E. Kim, Approximation algorithms for some routing problems, *SIAM J. on Computing* 7 (1978) 178-193.
- [9] M. R. Garey, D. S. Johnson, *Computers and intractability. a guide to the theory of NP-completeness*, CA, Freeman, 1979.
- [10] R. Hassin, S. Khuller, z -approximations, *Journal of Algorithms* 41 (2001) 429-442.
- [11] R. Hassin, S. Rubinstein, An Approximation Algorithm for Maximum Packing of 3-Edge Paths, *Information Processing Letters* 63 (1997) 63-67.

- [12] R. Hassin, S. Rubinstein, An Approximation Algorithm for Maximum Triangle Packing, *Discrete Applied Mathematics*, 154:6 (2006) 971-979.
- [13] J. Monnot, Differential approximation results for the traveling salesman and related problems, *Information Processing Letters* 82 (2002) 229-235.
- [14] J. Monnot, Differential approximation of **NP**-hard problems with constant size feasible solutions, *RAIRO/operations research*, 36(4) (2002) 279-297.
- [15] S. Sahni, T. Gonzalez, P-complete approximation problems, *Journal of the Association for Computing Machinery* 23 (1976) 555-565.
- [16] G. Steiner, On the k -path partition of graphs, *Theoretical Computer Science* 290 (2003) 2147-2155.